

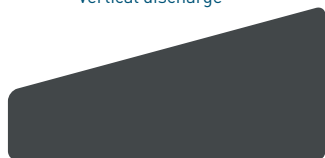

FCP - Flusso orizzontale
Horizontal discharge



FCP-V - Flusso verticale
Vertical discharge



Conformi alla Direttiva
ErP 125/2009/CE
e al Regolamento
UE 1253/2014

(Classifica: Unità di Ventilazione)

Comply with ErP Directive
2009/125/CE
and EU Regulation
1253/2014

(Classification: Ventilation Unit)

VERSIONI | VERSIONS



FCP ATEX - FCP-V ATEX

Versione antideflagrante secondo la
Direttiva 2014/34/UE
Explosion-proof version according to
Directive 2014/34/UE

FCP - FCP-V

Torrini centrifughi ad alte prestazioni High performance centrifugal roof fans



DESCRIZIONE

I torrini d'estrazione centrifughi delle serie FCP (flusso orizzontale) e FCP-V (flusso verticale) sono destinati all'aspirazione, diretta o canalizzata, nelle più svariate applicazioni civili, industriali e commerciali. Caratterizzati da una notevole semplicità d'installazione, si distinguono per l'elevata silenziosità ed efficienza. Il motore è separato dal flusso d'aria convogliato, questo permette di poter aspirare aria pulita o leggermente polverosa con temperatura da -20°C a +80°C.

COSTRUZIONE

- Telaio di base in lamiera d'acciaio zincato.
- Rete di protezione in filo d'acciaio trafilato e protetto contro gli agenti atmosferici fino al modello 350. I restanti modelli sono in lamiera zincata microstirata quadra e protetta contro gli agenti atmosferici. Realizzata a norme EN ISO 12499.
- Girante a pale rovesce autopulenti, ad alto rendimento aeraulico e bassa rumorosità, in lamiera zincata, bilanciata staticamente e dinamicamente secondo ISO 1940.
- Copertura in ABS con idonee feritoie per il corretto raffreddamento del motore.
- FCP-V: convogliatore in ABS.

MOTORIZZAZIONI

Motore asincrono trifase o monofase a norme internazionali IEC 60034, IEC 60072, EMC 2014/30/UE, LVD 2014/35/UE, marcato CE, IP55, classe F.
Idoneo ad un servizio continuo (S1).

ACCESSORI

TS - Serranda a gravità in aspirazione
GR - Silenziatore
CB - Controbasi a murare
BA - Basi d'appoggio su coperture ondulate
RA - Rete lato aspirazione
Interruttore di servizio
PB - Base d'appoggio/riduzione silenziosa
CCr - Rete di protezione piana.

A RICHIESTA

- Versioni a 60 Hz

DESCRIPTION

The centrifugal roof fans of the FCP (horizontal discharge) and FCP-V (vertical discharge) series are designed for direct or ducted ventilation in residential, commercial and industrial buildings. They are designed for easy installation, high efficiency low noise level. The motor is separated from the air flow, this allows the fan to exhaust clean or slightly dusty air with temperature from -20°C to +80°C.

CONSTRUCTION

- Base frame in galvanized steel sheet.
- Protection guard in drawn steel wire protected against the atmospheric agents, up to model 350. The remaining models are in square micro-pressed steel sheet. Manufactured according to EN ISO 12499.
- Backward curved wheel in galvanized steel sheet, with high efficiency and low noise level, statically and dynamically balanced according ISO 1940.
- Upper cover in ABS, with appropriate slots for motor cooling
- ABS conveyor on FCP-V.

MOTOR

Asynchronous three-phase motor or single-phase motor manufactured according to international standards IEC 600034, IEC 60072, EMC 2014/30/UE, LVD 2014/35/UE, CE marked, IP 55, class F.
Service S1 (continuous working at constant load).

ACCESSORIES

TS - Backdraught gravity shutter
GR - Silencer
CB - Counterbase to wall up
BA - Support base for wawed roof coverings
RA - Inlet Protection Guard
Service switch
PB - Support base/Silenced reduction
CCr - Flat protection guard.

UPON REQUEST

- Versions at 60 Hz

PRESTAZIONI | PERFORMANCE

FCP | FCP-V

Le prestazioni aerauliche sono rilevate in conformità alla norma EN ISO 5801/AMCA 210 con densità dell'aria standard avente peso specifico 1,2 Kg/m³. Alimentazione 230V/1Ph/50Hz o 400V/3Ph/50Hz. In conformità al regolamento UE 1253-14, le Unità di Ventilazione a singolo flusso devono essere abbinate a un azionamento a velocità multiple o variatore di velocità [VSD].
Air performances measured according to EN ISO 5801 / AMCA 210 standard with air density with 1.2 kg/m³ specific weight. Power supply 230V/1Ph/50Hz or 400V/3Ph/50Hz. In conformity to EU regulation 1253-14, single flow ventilation units must be connected to a VSD (Variable Speed Drive) when put into service.

L_w Livello di potenza sonora ottenuto secondo norma AMCA 300-08 in camera riverberante. Installazione C (open outlet). Tolleranza +/- 3 dB(A).
Sound power level obtained according to AMCA 300-08 in reverberating room. Installation C (open outlet). Tolerance +/- 3 dB(A).

FCP - FCP-V 350

Code	Tipo Type	Modello Model	U	P	P _m (kW)	I _n (A)	IP/CL	IE3	Mot. (Gr)
1FC1351	FCP	354 3600 0,25 kW	M	4	0,25	1,90	55/F	-	71
1FV1351	FCP-V								
1FC1350	FCP	354 3600 0,25 kW	T	4	0,25	0,80	55/F	-	71
1FV1350	FCP-V								

LIVELLI SONORI | SOUND LEVELS dB(A)

Hz		63	125	250	500	1000	2000	4000	8000	TOT
FCP 354	L _w	46	70	72	75	76	73	72	66	81
FCP-V 354	L _w	43	71	73	76	74	71	70	65	81

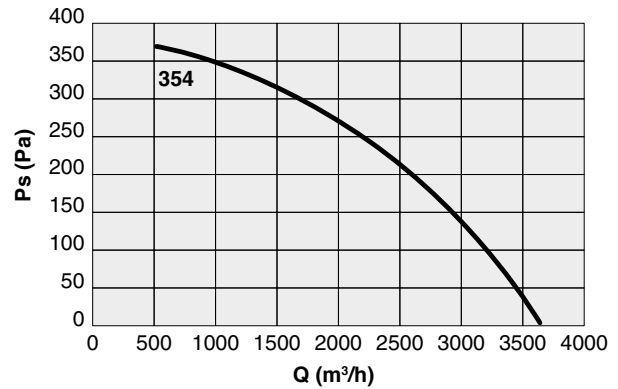

FCP - FCP-V 400

Code	Tipo Type	Modello Model	U	P	P _m (kW)	I _n (A)	IP/CL	IE3	Mot. (Gr)
1FC1401	FCP	404 5400 0,55 kW	M	4	0,55	4,00	55/F	-	80
1FV1401	FCP-V								
1FC1400	FCP	404 5400 0,55 kW	T	4	0,55	1,60	55/F	-	80
1FV1400	FCP-V								

LIVELLI SONORI | SOUND LEVELS dB(A)

Hz		63	125	250	500	1000	2000	4000	8000	TOT
FCP 404	L _w	48	74	77	79	79	74	76	66	85
FCP-V 404	L _w	46	74	76	77	77	74	76	66	84

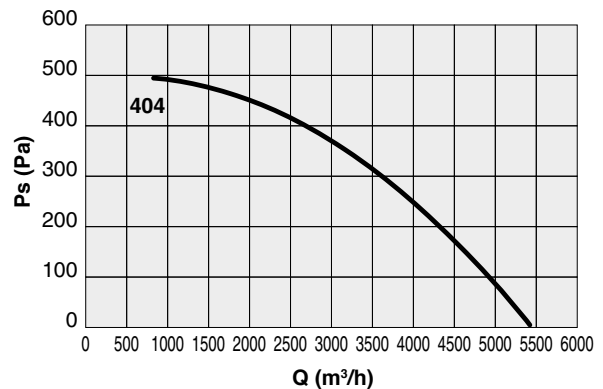

FCP - FCP-V 450

Code	Tipo Type	Modello Model	U	P	P _m (kW)	I _n (A)	IP/CL	IE3	Mot. (Gr)
1FC1451	FCP	454 7600 0,75 kW	M	4	0,75	4,80	55/F	✓	80
1FV1451	FCP-V								
1FC1450	FCP	454 7600 0,75 kW	T	4	0,75	2,10	55/F	✓	80
1FV1450	FCP-V								

LIVELLI SONORI | SOUND LEVELS dB(A)

Hz		63	125	250	500	1000	2000	4000	8000	TOT
FCP 454	L _w	51	77	81	84	84	79	81	69	90
FCP-V 454	L _w	49	78	80	81	82	78	80	68	88

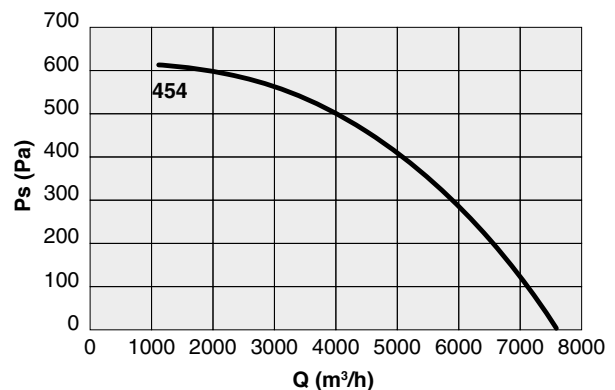

FCP - FCP-V 500

Code	Tipo Type	Modello Model	U	P	Pm (kW)	In (A)	IP/CL	IE3	Mot. (Gr)
1FC1500	FCP	504 T 10000	1,5 kW	T	4	1,5	3,30	55/F	✓ 90
1FV1500	FCP-V								

LIVELLI SONORI | SOUND LEVELS dB(A)

Hz		63	125	250	500	1000	2000	4000	8000	TOT
FCP 504	Lw	52	78	82	85	86	81	82	71	91
FCP-V 504	Lw	52	78	82	84	84	81	82	71	90

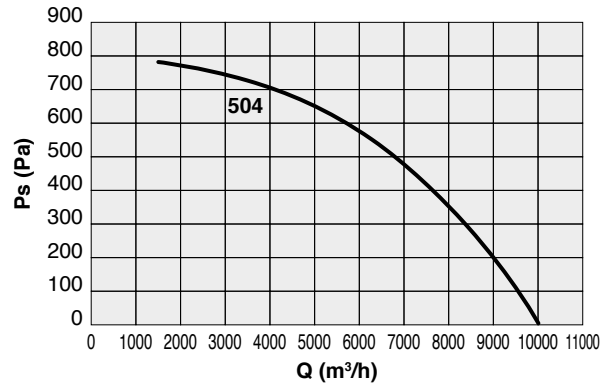

FCP - FCP-V 560

Code	Tipo Type	Modello Model	U	P	Pm (kW)	In (A)	IP/CL	IE3	Mot. (Gr)
1FC1561	FCP	564 14150	3 kW	T	4	3	6,30	55/F	✓ 100
1FV1561	FCP-V								
1FC1560	FCP	566 9100	0,55 kW	T	6	0,55	1,80	55/F	- 80
1FV1560	FCP-V								

LIVELLI SONORI | SOUND LEVELS dB(A)

Hz		63	125	250	500	1000	2000	4000	8000	TOT
FCP 564	Lw	64	85	84	87	87	88	80	73	94
FCP-V 564	Lw	62	86	86	85	85	88	80	73	93
FCP 566	Lw	54	75	74	77	77	78	70	63	84
FCP-V 566	Lw	53	77	76	76	75	78	70	64	84

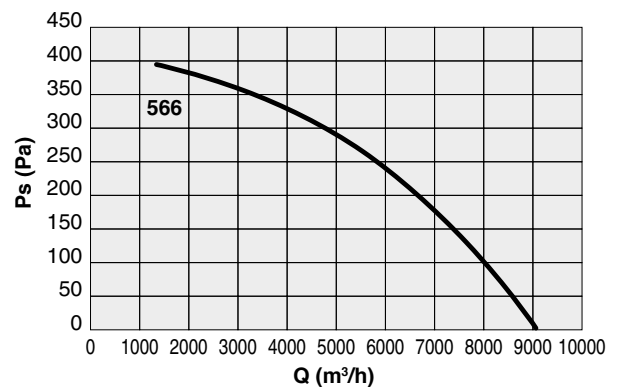
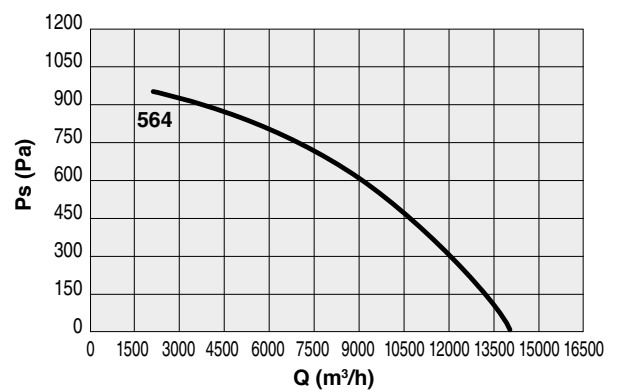

FCP - FCP-V 630

Code	Tipo Type	Modello Model	U	P	Pm (kW)	In (A)	IP/CL	IE3	Mot. (Gr)
1FC1631	FCP	634 21200	5,5 kW	T 4	5,5	10,4	55/F	✓	132
1FV1631	FCP-V								
1FC1630	FCP	636 13700	1,1 kW	T 6	1,10	2,80	55/F	✓	90
1FV1630	FCP-V								

LIVELLI SONORI | SOUND LEVELS dB(A)

Hz	63	125	250	500	1000	2000	4000	8000	TOT
FCP 634	Lw 67	88	90	93	90	91	88	76	98
FCP-V 634	Lw 66	89	89	89	88	89	90	84	97
FCP 636	Lw 57	78	80	83	80	81	78	66	88
FCP-V 636	Lw 57	80	79	80	78	79	80	75	87

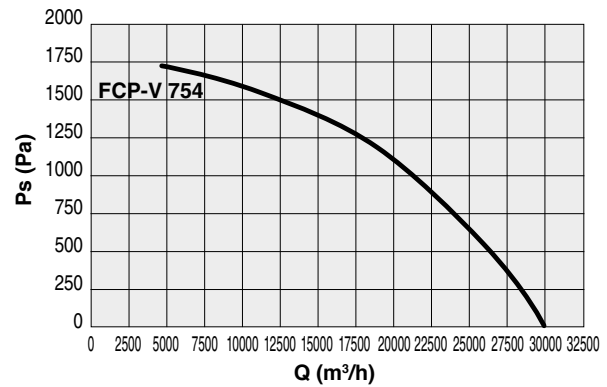
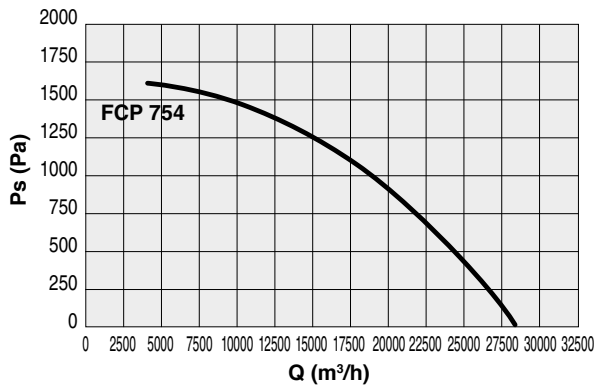
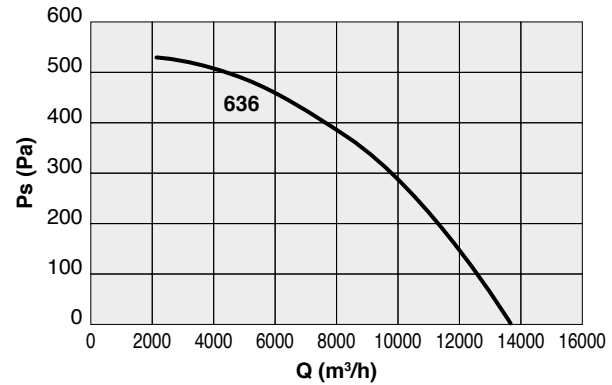
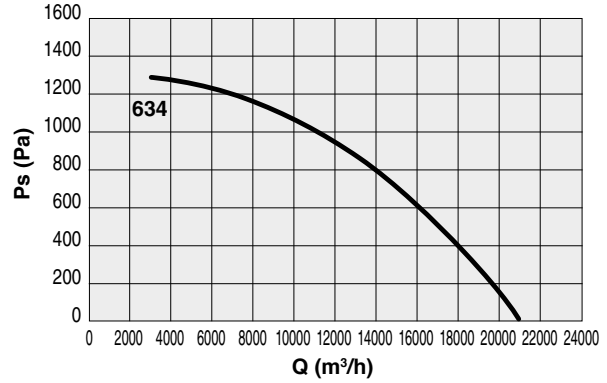

FCP - FCP-V 750

Code	Tipo Type	Modello Model	U	P	Pm (kW)	In (A)	IP/CL	IE3	Mot. (Gr)
1FC1751	FCP	754 29900	9,2 kW	T 4	9,2	17,6	55/F	✓	132
1FV1751	FCP-V	754 30400	9,2 kW						
1FC1750	FCP	756 19500	2,2 kW	T 6	2,2	5,0	55/F	✓	112
1FV1750	FCP-V								

LIVELLI SONORI | SOUND LEVELS dB(A)

Hz	63	125	250	500	1000	2000	4000	8000	TOT
FCP 754	Lw 77	92	94	97	97	99	86	79	104
FCP-V 754	Lw 73	91	93	94	94	97	85	78	101
FCP 756	Lw 67	82	84	87	87	89	76	69	94
FCP-V 756	Lw 64	82	83	85	84	87	75	69	92

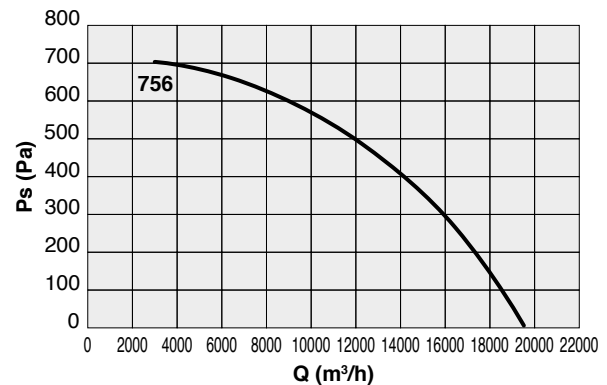

FCP - FCP-V 800

Code	Tipo Type	Modello Model	U	P	Pm (kW)	In (A)	IP/CL	IE3	Mot. (Gr)		
1FC1800	FCP	806	22500	3,0 kW	T	6	3	6,20	55/F	✓	132
1FV1800	FCP-V										

LIVELLI SONORI | SOUND LEVELS dB(A)

Hz	63	125	250	500	1000	2000	4000	8000	TOT	
FCP 806	Lw	68	83	85	88	88	90	77	70	95
FCP-V 806	Lw	72	87	89	92	92	94	81	74	99

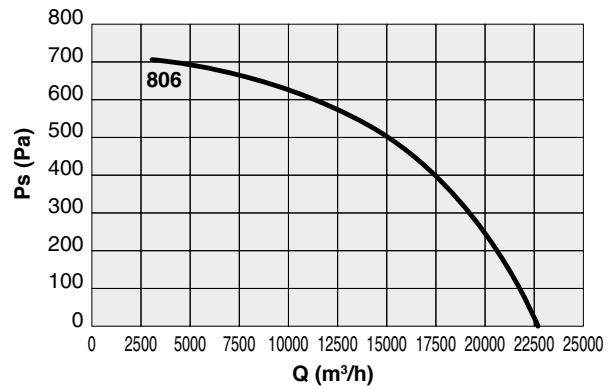

FCP - FCP-V 900

Code	Tipo Type	Modello Model	U	P	Pm (kW)	In (A)	IP/CL	IE3	Mot. (Gr)		
1FC1900	FCP	906	30000	5,5 kW	T	6	5,5	11,10	55/F	✓	132
1FV1900	FCP-V										

LIVELLI SONORI | SOUND LEVELS dB(A)

Hz	63	125	250	500	1000	2000	4000	8000	TOT	
FCP 906	Lw	70	85	90	93	90	92	84	72	98
FCP-V 906	Lw	70	85	90	93	90	92	84	72	98

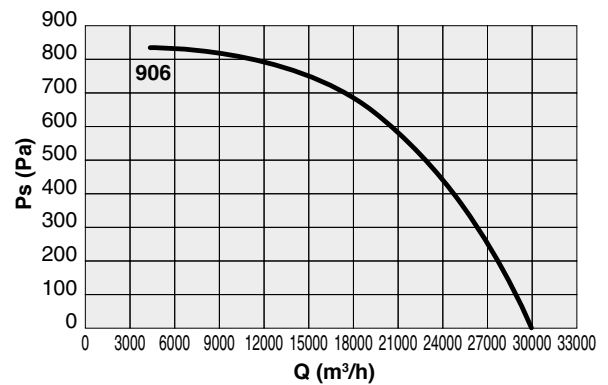

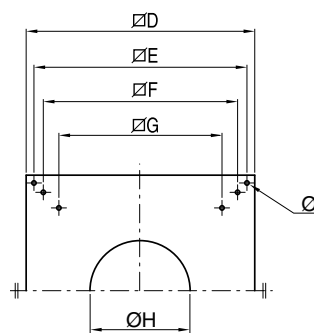
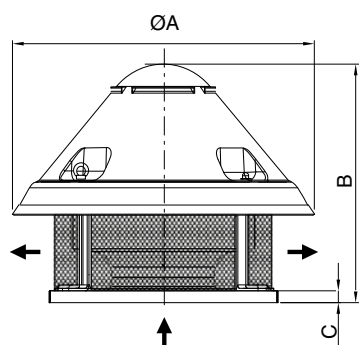

FCP

Code	$\varnothing A$	B	C	D	E	F	G	$\varnothing H$	$\varnothing I$	kg
FCP 350	755	630	38	500	450	-	370	237	12	30
FCP 400	910	670	38	650	600	521	471	269	12	45
FCP 450	910	700	38	650	600	521	471	301	12	50
FCP 500	1000	790	38	760	710	630	550	331	14	80
FCP 560	1000	830	38	760	710	630	550	370	14	70 (4p : 90)
FCP 634	1100	1025	38	930	870	775	665	418	14	120
FCP 636	1100	930	38	930	870	775	665	418	14	120
FCP 754	1100	1075	38	930	870	775	665	470	14	210
FCP 756	1100	980	38	930	870	775	665	470	14	170
FCP 800	1400	1150	38	1100	1030	895	785	470	14	220
FCP 900	1400	1180	38	1100	1030	895	785	530	14	250

Pesi indicativi | Indicative weights

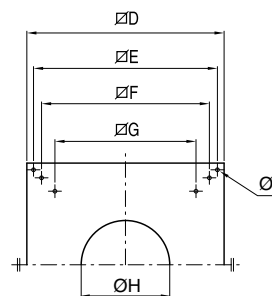
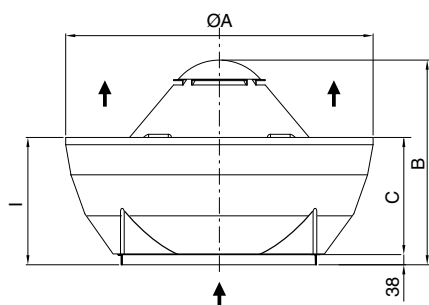

FCP-V

Code	$\varnothing A$	B	C	D	E	F	G	$\varnothing H$	$\varnothing I$	kg
FCP-V 350	800	630	300	500	450	-	370	237	12	34
FCP-V 400	980	670	360	650	600	521	471	269	12	50
FCP-V 450	980	700	360	650	600	521	471	301	12	55
FCP-V 500	1200	790	450	760	710	630	550	331	14	86
FCP-V 560	1200	830	450	760	710	630	550	370	14	76 (4p : 96)
FCP-V 634	1400	1025	500	930	870	775	665	418	14	167
FCP-V 636	1400	930	500	930	870	775	665	418	14	127
FCP-V 754	1400	1075	500	930	870	775	665	470	14	217
FCP-V 756	1400	980	500	930	870	775	665	470	14	172
FCP-V 800	1600	1150	600	1100	1030	895	785	470	14	228
FCP-V 900	1600	1180	600	1100	1030	895	785	530	14	258

Pesi indicativi | Indicative weights



GR | SILENZIATORI | SILENCERS

Silenziatori con setto centrale, riducono la rumorosità del torrino. Materiale fonoassorbente in lana minerale. Struttura portante in lamiera zincata. Attenzione: l'utilizzo del silenziatore abbinato alla serranda TS, l'utilizzo della versione con setto ribassato.

Silencers with central pod. They reduce the noise of the fan. Sound absorbing material: mineral wool. Frame in galvanized steel sheet. Attention: the use of a Silencer together with a TS shutter requires the use of the silencer with lowered pod.

Code (I)	Code (II)	Tipo Type	A	B	B ribassato lowered	C	D	E	F	G	ØH	kg
1SI0350	1SI0457	GR 35	750	650	400	490	450	120	150	50	M8	37
1SI0400	1SI0454	GR 40	750	650	350	640	600	145	250	50	M8	42
1SI0400	1SI0454	GR 45	750	650	350	640	600	145	250	50	M8	42
1SI0560	1SI0458	GR 50	750	650	300	750	710	200	250	50	M10	42
1SI0560	1SI0458	GR 56	750	650	300	750	710	210	250	50	M10	50
1SI0630	1SI0691	GR 63	1000	800	500	920	870	210	400	50	M10	79
1SI0630	1SI0691	GR 75	1000	800	500	920	870	210	400	50	M10	79
1SI0650	1SI0851	GR 80	1000	800	500	1080	1030	980	400	50	M10	89
1SI0850	1SI0851	GR 90	1000	800	500	1080	1030	980	400	50	M10	89

(I) Versione standard | Standard version - (II) Versione con setto ribassato | Version with lowered pod

ATTENUAZIONE IN dB PER BANDA DI OTTAVA (Hz) OCTAVE (Hz) SPECTRUM OF NOISE ATTENUATION IN dB

Tipo Type	63	125	250	500	1000	2000	4000	8000
GR 35	3	5	9	11	19	20	18	14
GR 40	3	4	8	9	18	15	10	6
GR 45	3	4	8	9	18	15	10	6
GR 50	4	5	11	15	16	12	9	5
GR 56	4	5	11	15	16	12	9	5
GR 63	3	4	5	8	14	9	7	3
GR 75	3	4	5	8	14	9	7	3
GR 80	3	4	5	8	14	9	7	3
GR 90	3	4	5	8	14	9	7	3

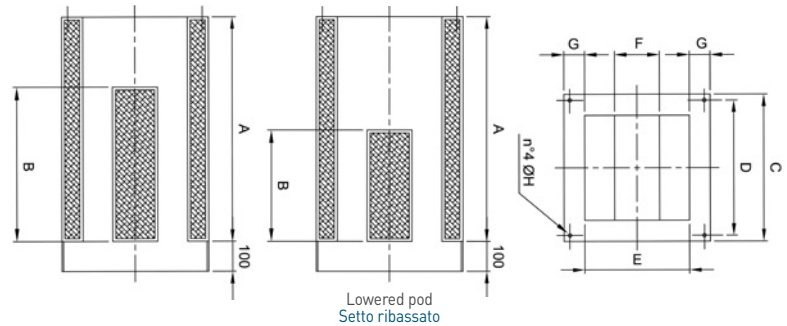

TS | SERRANDE A GRAVITÀ | GRAVITY SHUTTER

Evitano inutili dispersioni di calore e richiedono un'irrelevante perdita di carico. Le alette della serranda si aprono con la depressione dell'aria generata dal ventilatore in moto e si chiudono per gravità al suo spegnimento. La struttura è realizzata in lamiera zincata. Nel caso di utilizzo con silenziatore, utilizzare la versione di silenziatore con setto ribassato.

They avoid heat dispersion through the roof when this fan is not working with a negligible opening pressure. The shutter flaps are opened by the air depression produced by the fan when working, and they shut down by gravity after switching-off. The structured is made in galvanized steel sheet. In case of use with silencer, the version of silencer with lowered pod has to be used.

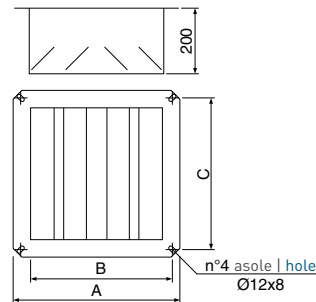

Code	Tipo Type	A	B	C	kg
5TS1950	TS 35	425	325	370	5
5TS1951	TS 40/45	505	405	471	6
5TS1952	TS 50/56	610	510	550	7
5TS1953	TS 63/75	820	720	780	8
5TS1953	TS 80/90	820	720	780	8

CB | CONTROBASI A MURARE | COUNTER BASES TO BE WALLED UP

La controbase garantisce un efficace ancoraggio al cavedio, tramite la muratura delle quattro zanche appositamente realizzate. Manufatto realizzato in robusta lamiera con predisposto il fissaggio alla base del torrino.

The counter base ensures an effective anchorage to the concrete support, through the fixing of four metal strips suitably designed. It is made in solid steel with arrangement for fixing to the fan base.

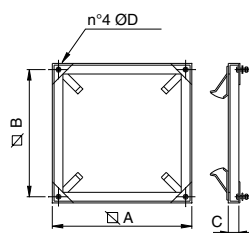

Code	Tipo Type	A	B	C	ØD	kg
1CB3500	CB 35	490	450	30	M8X30	2,8
1CB4000	CB 40	630	600	30	M8X30	3,2
1CB4000	CB 45	630	600	30	M8X30	3,2
1CB5500	CB 50	740	710	30	M10X40	3,6
1CB5500	CB 56	740	710	30	M10X40	3,6
1CB6000	CB 63	900	870	30	M10X40	4,0
1CB6000	CB 75	900	870	30	M10X40	4,0
1CB8000	CB 80	1070	1030	30	M10X40	5,0
1CB8000	CB 90	1070	1030	30	M10X40	5,0



BA | BASE D'APPOGGIO PER TORRINI | SUPPORT BASE FOR ROOF FANS

DESCRIZIONE - Le basi d'appoggio BA e la riduzione RD sono adatte per l'installazione dei nostri torrini su coperture costruite in lastre ondulate, evitando dannosi ristagni d'acqua attorno al ventilatore e costose opere murarie o di carpenteria. La base d'appoggio BA è utilizzabile per torrini aventi basamento da 930x930. Con l'apposita riduzione RD è possibile utilizzare la base per basamenti di torrini fino ad un minimo di 500x500. La riduzione RD è un unico elemento dove con un semplice taglio si elimina la parte eccedente.

VERSIONI

- BA 10x177 (Cod. 5PL1008) La base è accoppiabile a lastre tipo "EURO" passo 177 mm, altezza 51 mm e pendenza falda pari al 10%.
- BA 3x177 (Cod. 5PL1015) La base è accoppiabile a lastre tipo "EURO" passo 177 mm, altezza 51 mm e raggio di curvatura lastra pari a 3 metri.
- BA 10x146 (Cod. 5PL1009) La base è accoppiabile a lastre tipo "INTERNAZIONALE" passo 146 mm, altezza 48 mm, pendenza falda pari al 10%.
- Riduzione RD (Cod. 5PL1010).

COSTRUZIONE - In resine poliestere rinforzato con fibra di vetro stratificato. La finitura è RAL 9002 (grigio chiaro). La superficie esterna è trattata per resistere nel tempo agli agenti atmosferici.

POSA IN OPERA - Una posa corretta prevede la sovrapposizione alla lastra di copertura a valle e una sottoposizione a monte. Inoltre è da prevedere una sovrapposizione laterale di almeno un'onda e un quarto per lato.

DESCRIPTION - The support base BA and reduction RD are suitable for installation of roof fans on waved coverings, avoiding detrimental stagnation of water near to the fan and expensive carpentry works. The support base BA is suitable for roof fans having base 930mm X 930 mm or bigger. With the suitable reduction RD it is possible to use the base for roof fans from a minimum base dimension of 500X500. The reduction RD is a single element that can be easily cut to fit the exact fan dimension.

VERSION

- BA 10x177 (Cod. 5PL1008): suitable for "EURO" roof coverings pitch 177, height 51 mm and 10% slope.
- BA 3x177 (Cod. 5PL1015): suitable for "EURO" roof coverings pitch 177 mm, height 51 mm and radius of curvature of the sheet of 3 meters.
- BA 10x146 (Cod. 5PL1009): suitable for "INTERNATIONAL" roof coverings pitch 146 mm, height 48 mm, and 10% slope.
- Reduction RD (Cod. 5PL1010).

CONSTRUCTION - In polyester resins strengthen with stratified fibre glass. The finishing is RAL 9002 (light grey). The external surface is treated against the action of atmospheric agent.

INSTALLATION - A correct fitting foresees the overlap to the covering slab downstream and the underexposure upstream. Furthermore it must be foreseen a side overlap of at least one and quarter wave for each side.

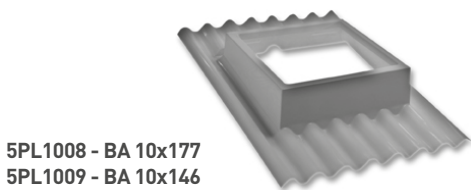

5PL1008 - BA 10x177
5PL1009 - BA 10x146

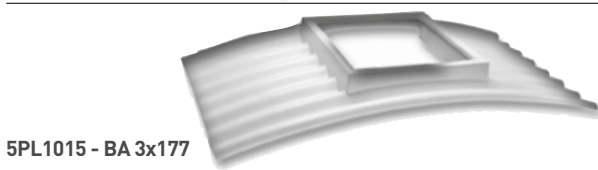
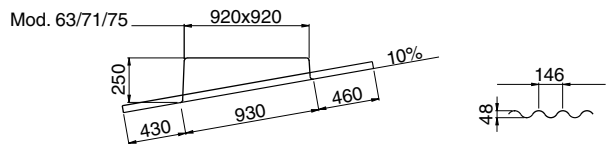

5PL1015 - BA 3x177

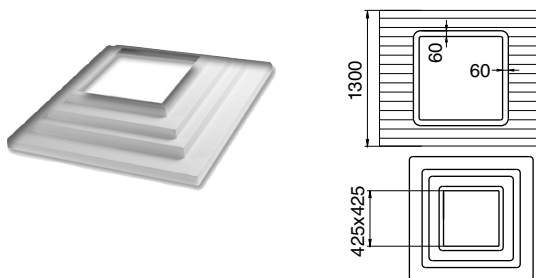
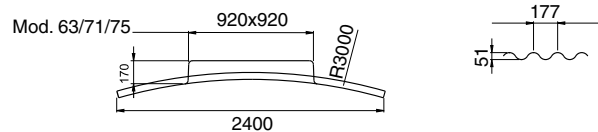

5PL1010 - RD

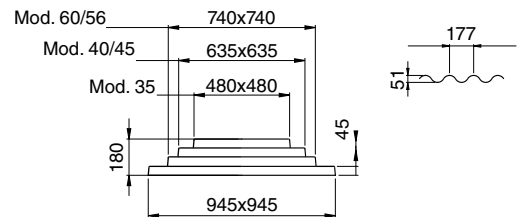

Dimensioni in mm | Dimensions in mm

PB | BASE D'APPOGGIO/ RIDUZIONE SILENZIATA PURLING BOX

La base d'appoggio/riduzione silenziata (PB), o purling box, è adatta per l'installazione dei nostri torrini su coperture piatte ed è comprensiva di isolamento acustico dal lato aspirazione del torrino. Struttura in lamiera zincata. Rivestimento fonoassorbente bugnato all'interno.

The silenced support base (PB) purling box is suitable for the installation of roof fans on flat covering. This support contains an acoustic isolation to reduce the noise of the fans at the inlet side support. Base frame in galvanized steel sheet. Internally lined with acoustic material.

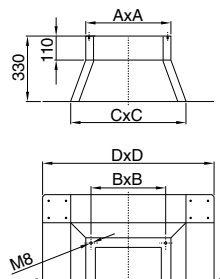

CCr | RETE PROTEZIONE BOCCA ASPIRANTE INLET PROTECTION GUARD

Salvaguardano dal contatto accidentale con le parti in movimento del ventilatore. Realizzate in filo d'acciaio, a norma UNI 12499 e protette contro gli agenti atmosferici.

They prevent from casual contact with moving parts of the fan. Manufactured in steel rod according to UNI 12499 standard and protected against atmospheric agents.

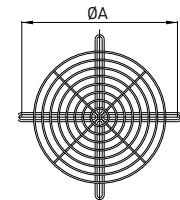

Code	Tipo Type	AxA	BxB	CxC	DxD
5PB3500	35	480	450	620	880
5PB4000	40/45	630	600	770	1030
5PB5000	50/56	740	710	880	1140
5PB6300	63/75	910	870	1050	1310
5PB8000	80/90	1070	1030	1210	1470

Dimensioni in mm | Dimensions in mm

Code	Tipo Type	Per modello For model	ØA	kg
5RE9051	CCr 50	FCP - FCP-V 35	560	1,3
5RE9064	CCr 63	FCP - FCP-V 40-45	620	1,9
5RE9083	CCr 80	FCP - FCP-V 50-56	690	3,0
5RE9093	CCr 90	FCP - FCP-V 63-75	970	3,4

CCr x FCP 80-90 | FCP-V 80-90 su richiesta | upon request

Dimensioni in mm | Dimensions in mm