



CCZ

Aspiratori assiali intubati compatti ad alta efficienza

Compact and high efficiency ducted axial fans



ErP 2009/125/CE



UE 327/2011

Conformi alla Direttiva ErP e al Regolamento UE 327/2011 (FAN)

Comply with ErP Directive and EU Regulation 327/2011 (FAN)



Modelli da 310 a 400

girante in tecnopolimero rinforzato con fibre minerali

Models from 310 to 400

impeller with blades in mineral fibres reinforced technopolymer

DESCRIZIONE

Gli aspiratori assiali intubati della serie CCZ sono utilizzati in applicazioni canalizzate in cui sono richieste consistenti portate e pressioni ridotte. Trovano impiego in impianti di ventilazione e raffreddamento in ambito industriale, navale, commerciale, civile ed energetico. Questa serie presenta una notevole facilità di montaggio e manutenzione grazie alla compattezza dovuta alla mancanza di parti sporgenti. I gruppi motore ventola sono perfettamente regolabili nella velocità di rotazione e presentano una ottima silenziosità di funzionamento. La serie è costituita da 6 modelli con diametro da 310 a 560 mm. L'impiego è previsto con aria pulita nell'intervallo di temperatura da -25°C a +60°C.

COSTRUZIONE

- Cassa in lamiera d'acciaio, con flange di fissaggio realizzate a norma UNI ISO 6580 - EUROVENT. Verniciata a polveri epossipoliestiriche.
- Girante con pale a profilo alare in tecnopolimero rinforzato con fibre minerali (310/400) e fusione in lega di alluminio (450/560) solidale al motore a rotore esterno.
- Esecuzione 5 (accoppiamento diretto con girante a sbalzo). Flusso dell'aria da motore a girante.

MOTORE

Motori a rotore esterno termoprotetti trifase a doppia velocità e monofase predisposti alla regolazione. Scatola portacontatti montata sul tamburo da 310 a 400. Da 450 a 560 montata su motore.

ACCESSORI

CCr - Rete di protezione piana
 CCga - Giunto antivibrante
 CCst - Staffe di fissaggio
 CCbo - Boccaglio in aspirazione/mandata
 CCsa e CCsb - Silenziatori con e senza ogiva con tre diverse lunghezze
 Ccf - Controflange piane
 CCfc - Controflange con collare
 Supporti antivibranti.

DESCRIPTION

The ducted axial fans of CCZ series are used for ducted installations requiring large airflow with relatively low pressure drop, like ventilation and cooling systems in industrial, naval, commercial, civil, energetic fields. These fans are particularly easy to install and to maintain thanks to their compact size and the total absence of protruding parts. The motor-impeller groups are perfectly speed controllable and ensure low noise running. The series consists of 6 different sizes with impeller diameter from 310 to 560 mm. The fans are suitable for conveying clean air with temperature from -25°C to +60°C.

CONSTRUCTION

- Short casing in steel sheet, with fixing flanges manufactured according to UNI ISO 6580-EUROVENT standard. Protected against atmospheric agents by epoxy paint.
- High quality aerofoil profiled impellers in mineral fibres reinforced technopolymer (310 to 400) and die cast a aluminum alloy (450 to 560). Blades are directly fixed to the motor external rotor.
- Execution 5 (with impeller directly coupled to the motor) and airflow from motor to impeller.

MOTOR

External rotor motors with built-in thermal protection, double speed three-phase and single-phase, speed adjustable. Connection box on the casing (up to model 400) and on the motor (models 450 to 560).

ACCESSORIES

CCr - Flat protection guard
 CCga - Flexible connectors
 CCst - Support feet
 CCbo - Inlet/outlet bell mouth
 CCsa and CCsb - Silencers, with and without pod, in three lengths
 Ccf - Counter flange flat
 CCfc - Counter flange with collar
 Anti-vibration mounts.

A RICHIESTA | UPON REQUEST

- Cassa zincata a caldo
- Versioni trasportabili con cavalletto (CCP)
- Casing protected against atmospheric agents by hotdip galvanizing
- Portable versions, with casing support (CCP)

PRESTAZIONI | PERFORMANCE

CCZ

Le prestazioni aerauliche sono rilevate in conformità alla norma EN ISO 5801/AMCA 210 con densità dell'aria standard avente peso specifico 1,2 Kg/m³. Conformi alla Direttiva ErP 2009/125/CE e al regolamento UE327/2011. Categoria di misura: C. Categoria di efficienza: Statica. Alimentazione 400V/3Ph/50Hz.
Air performances measured according to EN ISO 5801 / AMCA 210 standard with air density with 1.2 kg/m³ specific weight. Compliant with ErP 2009/125/EC Directive and EU Regulation 327/2011. Measurement category: C. Efficiency category: Static. Power supply 400V/3Ph/50Hz.

Lp Livello di pressione sonora rilevato in condizioni di campo libero, propagazione emisferica, categoria di misura C a norma EN ISO 13349, nel punto di massimo rendimento, alla distanza di 3 metri dal lato aspirazione e si presenta solo per fini comparativi.
Sound pressure level measured in free field conditions, propagation hemispherical, measurement category C in accordance with EN ISO 13349, at the point of maximum efficiency, at a distance of 3 meters, inlet side (for comparative purposes only).

Lw Livello di potenza sonora ottenuto secondo norma ISO 3746. Tolleranza +/- 3 dB(A).
Sound power level obtained in accordance with EN ISO 3746. Tolerance +/- 3 dB(A).

CCZ 310-350 Monofase | Single phase

Code	Tipo Type	Modello Model	U	P	Pm (kW)	In (A)	Capacità (mF) 400V	IP/CL
1CC0030	CCZ	314	M	4	0,10	0,42	3	54/F
1CC0035		354	M	4	0,12	0,56	5	54/F

LIVELLI SONORI | SOUND LEVELS dB(A)

Hz	SOUND LEVELS dB(A)									
	63	125	250	500	1000	2000	4000	8000	TOT	
310	Lw	36	60	61	64	69	63	51	72	
	Lp	18	42	43	46	51	45	30	55	
350	Lw	41	64	61	64	70	63	54	74	
	Lp	23	46	43	46	49	52	45	56	

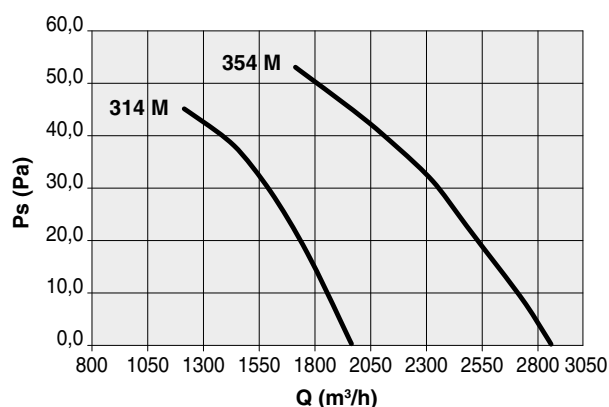

CCZ 400-450-500 Monofase | Single phase

Code	Tipo Type	Modello Model	U	P	Pm (kW)	In (A)	Capacità (mF) 400V	IP/CL
1CC0040	CCZ	404	M	4	0,24	1,05	5	54/F
1CC0045		454	M	4	0,60	2,90	7	44/F
1CC0050		504	M	4	0,72	3,20	16	54/F

LIVELLI SONORI | SOUND LEVELS dB(A)

Hz	SOUND LEVELS dB(A)									
	63	125	250	500	1000	2000	4000	8000	TOT	
400	Lw	45	67	71	72	74	75	69	80	
	Lp	27	49	53	54	56	57	51	62	
450	Lw	47	70	72	80	77	78	72	85	
	Lp	29	52	54	62	59	60	51	67	
500	Lw	49	72	74	74	76	77	73	83	
	Lp	31	54	56	56	58	59	55	65	

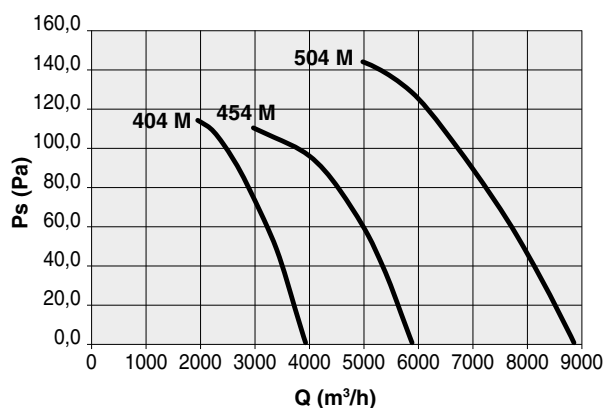

SEZ.
1.3

CCZ 400 Trifase | Three phase

Code	Tipo Type	Modello Model	U	P	Pm (kW)	In (A)	IP/CL
1CC0041	CCZ	404	T	4	0,23 0,17	0,46 0,27	54/F

LIVELLI SONORI | SOUND LEVELS dB(A)

Hz		63	125	250	500	1000	2000	4000	8000	TOT
400 Low	Lw	43	61	62	67	71	71	65	55	76
	Lp	25	43	44	49	53	53	47	34	58
400 High	Lw	44	65	66	70	74	75	70	60	79
	Lp	26	47	48	52	56	57	52	39	62

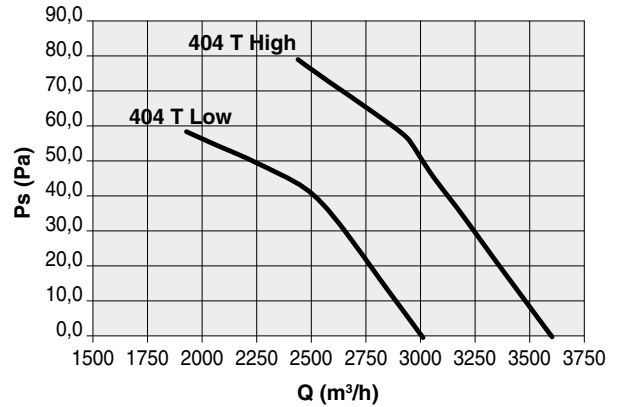

CCZ 450 Trifase | Three phase

Code	Tipo Type	Modello Model	U	P	Pm (kW)	In (A)	IP/CL
1CC0046	CCZ	454	T	4	0,54 0,36	1,10 0,66	44/F

LIVELLI SONORI | SOUND LEVELS dB(A)

Hz		63	125	250	500	1000	2000	4000	8000	TOT
450 Low	Lw	43	63	64	75	74	75	68	60	80
	Lp	25	45	46	57	56	57	50	39	62
450 High	Lw	49	69	71	74	79	79	75	66	84
	Lp	31	51	53	56	61	61	57	45	66

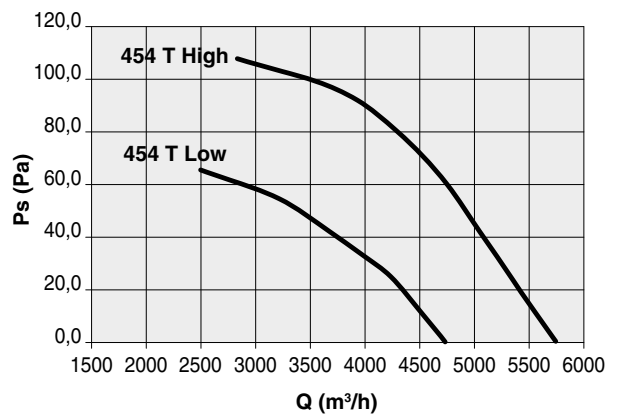

CCZ 500 Trifase | Three phase

Code	Tipo Type	Modello Model	U	P	Pm (kW)	In (A)	IP/CL
1CC0051	CCZ	504	T	4	0,84 0,54	1,45 0,96	54/F

LIVELLI SONORI | SOUND LEVELS dB(A)

Hz		63	125	250	500	1000	2000	4000	8000	TOT
500 Low	Lw	45	64	70	73	75	76	70	61	81
	Lp	27	46	52	55	57	58	52	40	63
500 High	Lw	50	73	72	77	81	80	77	68	86
	Lp	32	55	54	59	63	62	59	47	68

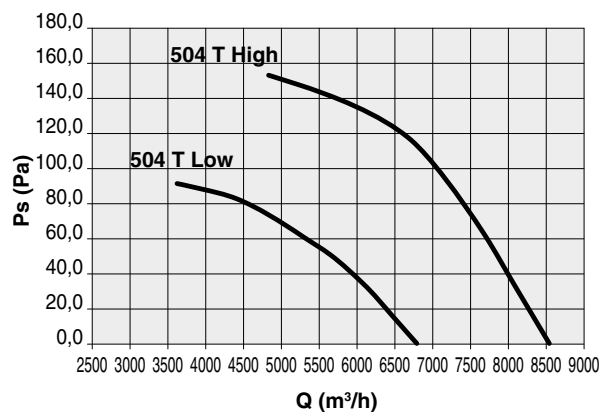

CCZ 560 Trifase | Three phase

Code	Tipo Type	Modello Model	U	P	Pm (kW)	In (A)	IP/CL
1CC0056	CCZ	564	T	4	1,05 0,58	2,20 1,10	54/F

LIVELLI SONORI | SOUND LEVELS dB(A)

Hz	63	125	250	500	1000	2000	4000	8000	TOT	
560 Low	Lw	52	67	70	76	80	80	74	66	85
	Lp	34	49	52	58	62	62	56	45	67
560 High	Lw	55	75	77	82	86	85	81	72	90
	Lp	37	57	59	64	68	67	63	51	73

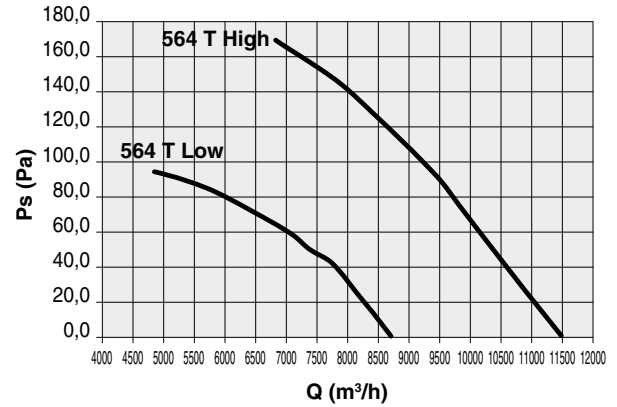

DIMENSIONI | DIMENSIONS mm

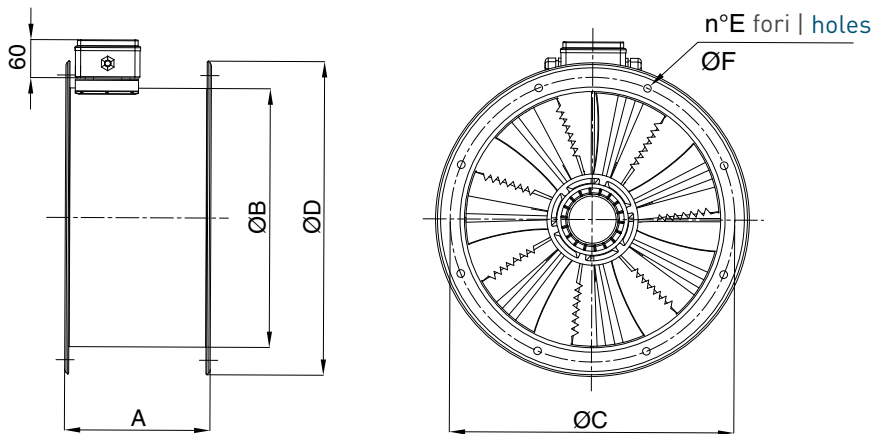

CCZ

TIPO TYPE	A	B	C	D	n°E	ØF	Kg
CCZ 310	200	305	355	395	8	10	10
CCZ 350	200	355	395	446	8	10	13
CCZ 400	230	405	450	496	8	12	16
CCZ 450	230	455	500	546	8	12	23
CCZ 500	250	505	560	598	12	12	26
CCZ 560	250	565	620	658	12	12	30

Pesi indicativi | Indicative weights

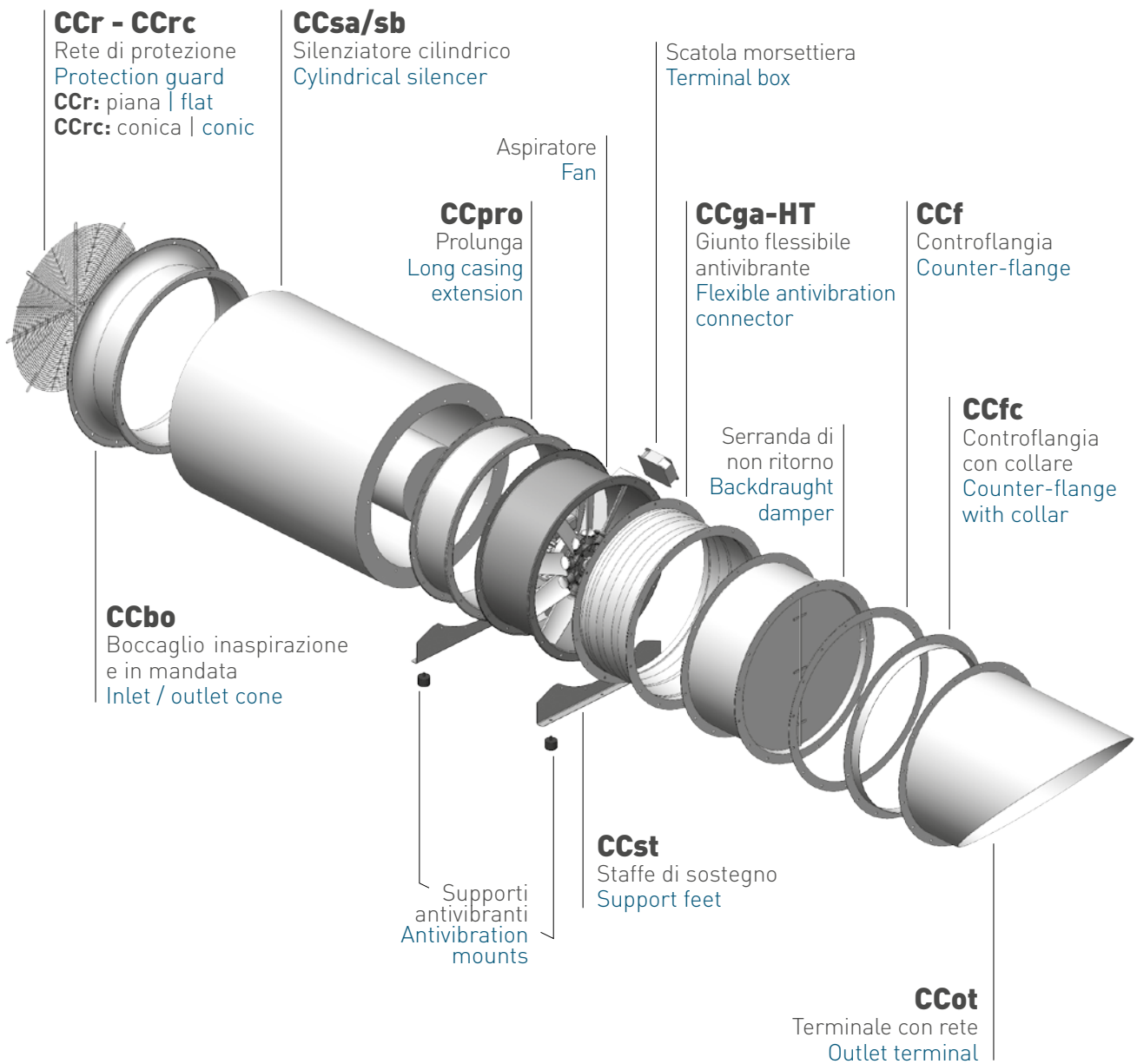



CCr - CCrc | RETI PROTEZIONE | PROTECTION GUARDS

Salvaguardano dal contatto accidentale con le parti in movimento del ventilatore. Realizzate in filo d'acciaio, a norma UNI 12499 e protette contro gli agenti atmosferici.
CCr: versione piana (per cassa lunga e cassa corta lato girante).
CCrc: versione conica (cassa corta lato motore).
 Disponibile solo per CC.

They prevent from casual contact with moving parts of the fan. Manufactured in steel rod according to UNI 12499 standard and protected against atmospheric agents.
CCr: flat version (for long case and short case on impeller side).
CCrc: conic version (short case version on motor side).
 Suitable on CC only.

CCr

Code	Tipo Type	ØA	kg
5RE9031	CCr 31	355	0,6
5RE9035	CCr 35	395	0,7
5RE9040	CCr 40	450	0,8
5RE9045	CCr 45	500	1,0
5RE9050	CCr 50	560	1,3
5RE9056	CCr 56	620	1,6
5RE9063	CCr 63	690	1,9
5RE9071	CCr 71	770	2,2
5RE9080	CCr 80	860	3,0
5RE9090	CCr 90	970	3,4
5RE9100	CCr 100	1070	3,5
5RE9102	CCr 112	1190	4,0
5RE9105	CCr 125	1320	4,5
5RE9110	CCr 140	1490	5,0
5RE9113	CCr 160	1690	6,0

CCrc

Code	Tipo Type	ØA	B	kg
5RE1581	CCrc 31	355	115	1
5RE1582	CCrc 35	395	115	1,1
5RE1583	CCrc 40	450	115	1,3
5RE1584	CCrc 45	500	115	1,5
5RE1585	CCrc 50	560	115	1,8
5RE1586	CCrc 56	620	115	2,2
5RE1587	CCrc 63	690	115	3
5RE1588	CCrc 71	770	150	4,5
5RE1589	CCrc 80	860	150	5,8
5RE1590	CCrc 90	970	305	7
5RE1591	CCrc 100	1070	305	8,5
5RE1592	CCrc 112	1190	305	10
5RE1593	CCrc 125	1320	305	11

1400/1600: su richiesta | upon request

Dimensioni in mm | Dimensions in mm

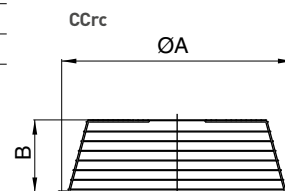
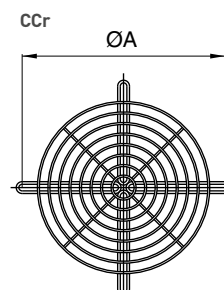

CCbo | BOCCAGLIO | INLET/OUTLET CONE

Permette un maggiore rendimento del ventilatore nel caso di bocche non canalizzate. Costruito in lamiera d'acciaio, con una flangia, realizzata a norma UNI ISO 6580 - EUROVENT, per il fissaggio al tamburo del CC e una bocca di aspirazione/diffusione ad ampio raggio con fori di fissaggio per rete CCr (di una taglia superiore, Es. CCbo 71 + CCr 80). Verniciato a polveri epossipoliestriche.

It allows a higher fan efficiency in case of installation with inlet or outlet not ducted. Manufactured in steel sheet, with one flange according to UNI ISO6580 - EUROVENT to be fitted to the CC fan, and an aerodynamically shaped bell mouth, with fixing holes for a protection guard (of one size bigger, example CCbo 71 + CCr 80). Protected against atmospheric agents by epoxy paint.

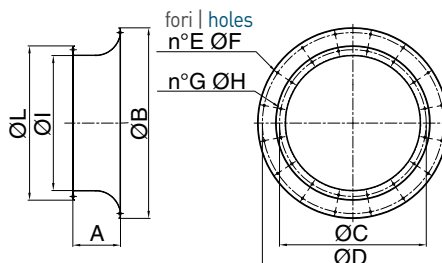

CCr di una taglia superiore of one size bigger

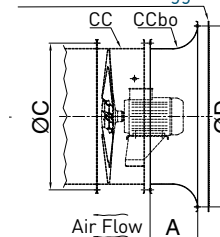

Esempi di installazione Installation example

Code	Tipo Type	A	ØB	ØC	ØD	E	ØF	G	ØH	ØI	ØL	kg
5B09631	CCbo 31	175	442	355	395	8	10	8	10	307	395	4,5
5B09635	CCbo 35	175	496	395	450	8	12	8	10	357	446	5
5B09640	CCbo 40	175	546	450	500	8	12	8	12	407	496	5,6
5B09645	CCbo 45	175	598	500	560	12	12	8	12	457	546	6,3
5B09650	CCbo 50	190	658	560	620	12	12	12	12	507	598	8,5
5B09656	CCbo 56	190	730	620	690	12	12	12	12	567	658	8,5
5B09663	CCbo 63	190	810	690	770	16	12	12	12	637	730	9,8
5B09671	CCbo 71	230	910	770	860	16	12	16	12	708	810	12,4
5B09680	CCbo 80	250	1025	860	970	16	16	16	12	808	910	15,2
5B09690	CCbo 90	300	1125	970	1070	16	16	16	16	910	1030	29,4
5B09700	CCbo 100	300	1245	1070	1190	20	16	16	16	1010	1130	33,3
5B09712	CCbo 112	300	1380	1190	1320	20	16	20	16	1130	1250	37,3
5B09725	CCbo 125	300	1525	1320	1470	20	16	20	16	1260	1380	42,5
5B09740	CCbo 140	300	1735	1470	1680	24	18	20	16	1415	1540	49,8
5B09760	CCbo 160	300	1935	1680	1880	24	18	24	18	1615	1750	57,2

Dimensioni in mm | Dimensions in mm

N.B.: Il flusso dell'aria potrebbe cambiare da girante a motore | Airflow direction could vary from impeller to motor.



CCsa | CCsb | SILENZIATORI CILINDRICI | CYLINDRICAL SILENCERS

I silenziatori cilindrici CCs sono disponibili in due versioni, senza ogiva (CCsa) e con ogiva (CCsb). La presenza dell'ogiva permette una maggiore attenuazione della rumorosità ma genera una perdita di carico aggiuntiva nell'impianto. Entrambe le versioni possono essere fissate alla flangia del CC corrispondente sia in aspirazione sia in mandata. La serie CCsa non genera perdite di carico aggiuntive. La serie CCsb, comporta una perdita di carico nella misura evidenziata nel diagramma di pagina 50. E' possibile fornire i silenziatori in versione di lunghezza pari a 1 - 1,5 - 2 volte il diametro (b). Questi silenziatori sono costruiti completamente in lamiera zincata, la parte interna e l'ogiva in lamiera forata al fine di permettere, efficacemente, l'azione del materasso fonoassorbente in lana minerale. La temperatura d'esercizio è compresa fra -40 e +150°C.

The cylindrical silencers CCs are available in two versions, without pod (CCsa) and with pod (CCsb). The presence of the pod allows a higher noise attenuation, but creates an additional pressure drop in the system. Both the versions can be fixed to the corresponding flange of the CC in inlet and outlet. The CCsa series doesn't create additional losses. The CCsb series gives an additional loss, as shown in the diagram at page 50.

Silencers can be provided with length equal to 1 - 1,5 - 2 times the diameter (b). These silencers are manufactured completely in galvanized steel. The internal part and the pod are made in perforated sheet, to effectively allow the sound absorption of the acoustic lining in mineral wool. The working temperature is included from -40°C and +150°C.

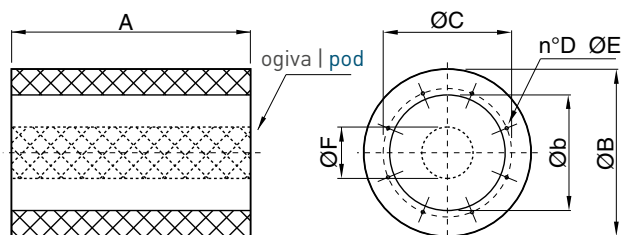

CCsa / CCsb

Tipo Type	ØB	Øb	ØC	D	ØE	ØF
31	455	315	355	8	M8	140
35	495	355	395	8	M8	200
40	540	400	450	8	M10	200
45	610	450	500	8	M10	245
50	660	500	560	12	M10	245
56	720	560	620	12	M10	295
63	790	630	690	12	M10	295
71	870	710	770	16	M10	380
80	1000	800	860	16	M10	380
90	1100	900	970	16	M12	380
100	1200	1000	1070	16	M12	650
112	1320	1120	1190	20	M12	650
125	1450	1250	1320	20	M12	650

CCsa

Tipo Type	A 1Ø	kg	A 1,5Ø	kg	A 2Ø	kg
CCsa 31	315	8	472	11	630	14
CCsa 35	355	10	532	14	710	17
CCsa 40	400	12	600	17	800	21
CCsa 45	450	15	675	20	900	24
CCsa 50	500	18	750	25	1000	32
CCsa 56	560	21	840	28	1120	35
CCsa 63	630	24	945	33	1260	43
CCsa 71	710	35	1065	49	1420	63
CCsa 80	800	43	1200	61	1600	79
CCsa 90	900	70	1350	94	1800	112
CCsa 100	1000	113	1500	137	2000	161
CCsa 112	1120	130	1680	154	2240	178
CCsa 125	1250	152	1875	185	2500	213

CCsb

Tipo Type	A 1Ø	kg	A 1,5Ø	kg	A 2Ø	kg
CCsb 31	315	10	472	14	630	16
CCsb 35	355	12	532	16	710	18
CCsb 40	400	14	600	21	800	26
CCsb 45	450	17	675	24	900	29
CCsb 50	500	23	750	32	1000	39
CCsb 56	560	28	840	37	1120	44
CCsb 63	630	32	945	44	1260	55
CCsb 71	710	44	1065	62	1420	78
CCsb 80	800	56	1200	79	1600	101
CCsb 90	900	130	1350	153	1800	175
CCsb 100	1000	143	1500	180	2000	216
CCsb 112	1120	165	1680	202	2240	238
CCsb 125	1250	193	1875	240	2500	282

Dimensioni in mm - Codici a richiesta
Dimensions in mm - Item code upon request

CCsb | DIAGRAMMA perdita di carico SILENZIATORI | SILENCER with pod loss charge DIAGRAM

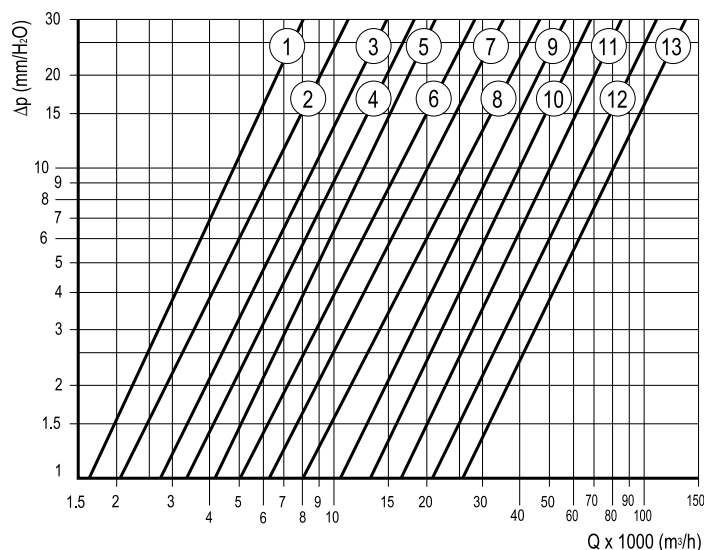

N.B.: Versioni senza ogiva (CCsa) hanno perdita di carico irrilevante.
Without pod (CCsa) loss charge irrelevant.

CCsb

Tipo Type	n°
CCsb 31	1
CCsb 35	2
CCsb 40	3
CCsb 45	4
CCsb 50	5
CCsb 56	6
CCsb 63	7
CCsb 71	8
CCsb 80	9
CCsb 90	10
CCsb 100	11
CCsb 112	12
CCsb 125	13



SILENZIATORI CILINDRICI Cylindrical silencers

CCsa silenzatori senza ogiva | without pod

Attenuazione in dB per banda di ottava (Hz)
Octave spectrum (Hz) of noise attenuation in dB

		A= 1 x Øb							
Tipo Type		63	125	250	500	1K	2K	4K	8K
31	1	1	3	8	14	9	8	7	
35	0	0	3	9	14	10	8	6	
40	0	0	4	10	13	8	8	5	
45	1	1	4	12	12	9	6	6	
50	0	0	4	13	11	9	6	5	
56	0	0	4	14	11	8	5	4	
63	1	1	5	14	10	9	5	5	
71	1	1	5	12	9	7	5	5	
80	2	3	7	9	8	6	5	4	
90	2	3	7	13	8	6	5	4	
100	2	3	8	12	8	4	4	4	
112	2	3	8	13	7	5	4	3	
125	2	3	9	13	7	4	4	3	

		A= 1,5 x Øb							
Tipo Type		63	125	250	500	1K	2K	4K	8K
31	1	2	5	12	19	13	11	8	
35	0	0	5	12	21	13	11	9	
40	1	1	5	14	19	12	10	8	
45	1	1	6	17	17	13	9	8	
50	1	1	6	18	17	12	9	7	
56	1	2	7	20	15	11	8	5	
63	1	2	7	20	14	12	8	6	
71	2	2	7	18	11	9	6	7	
80	2	5	10	13	12	9	7	7	
90	2	5	11	16	11	7	7	5	
100	2	5	12	17	10	6	6	5	
112	3	5	12	18	8	6	5	4	
125	3	6	12	17	8	5	5	4	

		A= 2 x Øb							
Tipo Type		63	125	250	500	1K	2K	4K	8K
31	4	6	6	16	26	17	13	9	
35	0	2	6	15	25	16	12	10	
40	0	2	7	18	24	15	12	9	
45	0	1	7	21	21	15	10	8	
50	1	2	8	23	21	14	11	8	
56	1	1	9	24	19	14	10	7	
63	1	2	9	25	17	14	10	7	
71	2	4	9	24	14	11	8	8	
80	4	6	13	22	14	10	9	7	
90	4	6	14	23	13	9	7	6	
100	4	6	16	23	12	7	7	6	
112	4	6	15	23	10	7	6	6	
125	5	8	17	22	10	6	6	5	

CCsb silenzatori con ogiva | with pod

Attenuazione in dB per banda di ottava (Hz)
Octave spectrum (Hz) of noise attenuation in dB

		A= 1 x Øb							
Tipo Type		63	125	250	500	1K	2K	4K	8K
31	0	1	4	9	16	17	13	10	
35	0	0	4	11	22	21	15	12	
40	0	1	4	11	20	18	14	11	
45	0	1	6	14	21	19	13	9	
50	1	2	5	13	20	16	11	8	
56	1	1	6	15	21	17	11	8	
63	1	1	6	15	19	16	10	8	
71	1	2	7	15	20	18	12	10	
80	2	3	9	12	17	15	9	8	
90	2	4	8	15	16	11	8	7	
100	4	8	14	20	24	21	14	10	
112	4	6	13	20	21	14	8	7	
125	4	7	12	18	19	10	6	6	

		A= 1,5 x Øb							
Tipo Type		63	125	250	500	1K	2K	4K	8K
31	2	4	5	13	23	26	18	12	
35	1	1	7	15	33	32	22	17	
40	1	2	6	15	31	27	19	14	
45	1	2	7	19	31	28	18	12	
50	2	3	7	19	29	24	14	10	
56	2	3	9	22	32	27	15	11	
63	2	2	9	22	29	23	14	10	
71	2	3	11	22	31	25	13	11	
80	3	6	13	18	26	22	12	11	
90	3	5	12	20	24	16	10	9	
100	6	10	22	30	37	29	16	12	
112	6	10	19	29	33	20	11	10	
125	6	10	18	26	29	14	9	7	

		A= 2 x Øb							
Tipo Type		63	125	250	500	1K	2K	4K	8K
31	3	6	7	17	32	33	22	17	
35	1	2	8	19	40	39	27	20	
40	1	2	9	20	37	35	23	16	
45	2	3	10	23	39	36	21	15	
50	2	3	10	24	38	32	18	12	
56	1	2	12	27	41	35	18	12	
63	2	3	11	27	37	29	15	12	
71	3	5	14	29	41	32	18	15	
80	3	6	16	29	35	26	15	12	
90	4	7	17	30	34	20	12	11	
100	7	13	28	39	47	38	19	13	
112	8	14	26	36	42	24	13	11	
125	7	13	25	35	37	17	11	9	



CCpro | PROLUNGA | LONG CASING EXTENSION (solo per | only for CC)

Permette la realizzazione, anche in sito, della versione a cassa lunga con girante e motore completamente protetti dalla cassa del ventilatore. Costruita in lamiera d'acciaio, con flange di fissaggio realizzate a norma UNI ISO 6580 - EUROVENT. Verniciata a polveri epossipoliestiriche. Completa di portellina d'ispezione e fori per passaggio cavi.

Turns the standard short case execution into a long case version, also at site, with impeller and motor completely protected inside the casing. Manufactured in steel sheet, with fixing flanges according to UNI ISO6580 - EUROVENT standard. Protected against atmospheric agents by epoxy-paint. Complete of inspection porthole and holes for cable

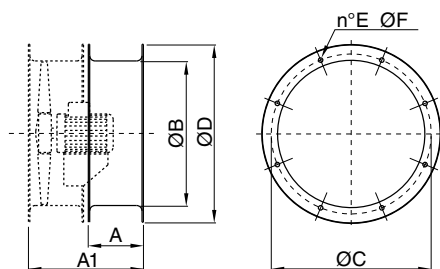

Code	Tipo Type	A	A1	ØB	ØC	ØD	E	ØF	kg
1CC9313	CCpro 31	180	380	305	355	395	8	10	4
1CC9351	CCpro 35	180	380	355	395	446	8	10	5
1CC9402	CCpro 40	200	430	400	450	496	8	12	6
1CC9451	CCpro 45	200	430	450	500	546	8	12	7
1CC9502	CCpro 50	200	450	500	560	598	12	12	8
1CC9561	CCpro 56	200	450	560	620	658	12	12	9
1CC9632	CCpro 63	240	490	630	690	730	12	12	11
1CC9712	CCpro 71	280	530	710	770	810	16	12	13
1CC9802	CCpro 80	240	590	800	860	910	16	12	20
1CC9901	CCpro 90	340	690	900	970	1030	16	16	31
1CC9912	CCpro 100	410	760	1000	1070	1130	16	16	39
1CC9921	CCpro 112	410	760	1120	1190	1250	20	16	58
1CC9927	CCpro 125	410	760	1250	1320	1380	20	16	65
1CC9930	CCpro 140	510	960	1415	1470	1540	20	16	88
1CC9931	CCpro 160	510	960	1615	1680	1730	24	18	98

I codici riportati sono quelli della prolunga montata.
The reported item codes are relative to the assembled extension.

CCga | GIUNTO ANTIVIBRANTE | FLEXIBLE CONNECTORS

Impedisce la propagazione delle vibrazioni sulla canalizzazione. Costruito con due flange in lamiera d'acciaio, realizzate a norma UNI ISO 6580 - EUROVENT per il fissaggio al ventilatore e al canale, ed un nastro di collegamento flessibile e robusto. Temperature d'utilizzo -30°C +80°C. Parti in lamiera verniciate a polveri epossipoliestiriche. Per temperature d'utilizzo diverse sono previste costruzioni speciali.

It prevents the propagation of vibrations along the ducted system. Manufactured with two flanges in steel sheet, according to UNI ISO6580 - EUROVENT standard for fixing to the fan and to the duct, and a strong flexible fabric joint. Working temperatures from -30°C to +80°C. Components in steel sheet protected against atmospheric agents by epoxy paint. Special .executions are available for different working temperatures

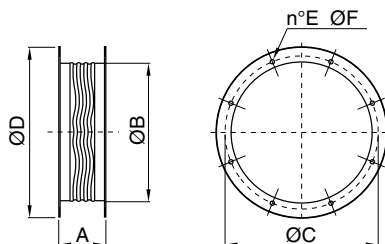

Code	Tipo Type	A	ØB	ØC	ØD	E	ØF	kg
1SU5310	CCga 31	200	305	355	395	8	10	5
1SU5350	CCga 35	200	355	395	446	8	10	6
1SU5400	CCga 40	200	405	450	496	8	12	7
1SU5450	CCga 45	200	455	500	546	8	12	8
1SU5500	CCga 50	200	505	560	598	12	12	9
1SU5560	CCga 56	200	565	620	658	12	12	10
1SU5630	CCga 63	200	635	690	730	12	12	11
1SU5710	CCga 71	200	708	770	810	16	12	13
1SU5800	CCga 80	200	808	860	910	16	12	21
1SU5900	CCga 90	200	908	970	1030	16	16	23
1SU6000	CCga 100	200	1010	1070	1130	16	16	26
1SU6120	CCga 112	200	1130	1190	1250	20	16	29
1SU6125	CCga 125	200	1260	1320	1380	20	16	32

Dimensioni in mm | Dimensions in mm
1400/1600: su richiesta | upon request

CCst | STAFFE DI SOSTEGNO | SUPPORT FEET

Consentono l'ancoraggio del ventilatore a pavimento o soffitto. Realizzate in lamiera d'acciaio e verniciate a polveri epossipoliestiriche. Fornite a coppia.

Suitable to fasten the fan on the floor or to the ceiling. Manufactured in steel sheet and protected against atmospheric agents by epoxy paint. Supplied in sets of 2

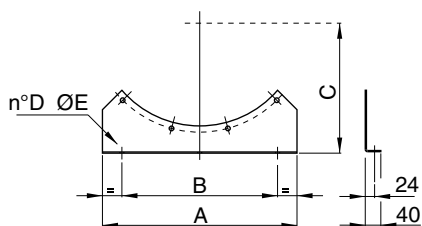

Code*	Tipo Type	A	B	C	D	ØE	kg**
1ST0310	CCst 31	320	200	280	2	10	1,1
1ST0350	CCst 35	350	250	300	2	10	1,25
1ST0400	CCst 40	400	300	320	2	10	1,3
1ST0450	CCst 45	450	350	350	2	10	1,5
1ST0500	CCst 50	500	400	380	2	10	2,1
1ST0560	CCst 56	560	460	410	2	10	2,5
1ST0630	CCst 63	630	480	450	2	10	2,8
1ST0710	CCst 71	710	550	490	2	10	3,1
1ST0800	CCst 80	800	660	540	3	14	3,7
1ST0900	CCst 90	900	760	600	3	14	4,5
1ST1000	CCst 100	1000	860	640	3	14	4,8
1ST1120	CCst 112	1120	980	710	3	14	6,8
1ST1250	CCst 125	1250	950	770	3	14	7,8
1ST1400	CCst 140	1400	1100	850	3	14	11
1ST1600	CCst 160	1600	1300	960	3	16	21,5

Dimensioni in mm - * Codice della coppia - ** Peso di una staffa
Dimensions in mm - *Item code of the set of 2 - **Weight of a single support



CCf | CONTROFLANGIA | COUNTER FLANGE

Piastra a forma di anello provvista di fori a norma UNI ISO 6580 – EUROVENT. Viene utilizzata per facilitare il collegamento tra il canale ed il ventilatore.

Ring plate with holes according to UNI ISO6580 – EUROVENT standard, compatible with fan flange. It is used for easier connection between the CC fan and the duct.

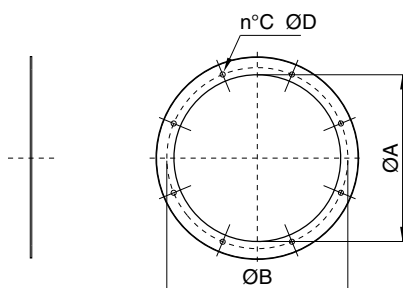

Code	Tipo Type	ØA	ØB	C	ØD	kg
5B01031	CCf 31	315	355	8	10	1,2
5B01035	CCf 35	350	395	8	10	1,5
5B01040	CCf 40	400	450	8	12	1,7
5B01045	CCf 45	450	500	8	12	1,9
5B01050	CCf 50	500	560	12	12	2,1
5B01056	CCf 56	560	620	12	12	2,4
5B01063	CCf 63	630	690	12	12	2,7
5B01071	CCf 71	710	770	16	12	3,3
5B01081	CCf 80	800	860	16	12	3,7
5B01092	CCf 90	900	970	16	16	4,7
5B01110	CCf 100	1000	1070	16	16	5,2
5B01212	CCf 112	1120	1190	20	16	6,5
5B01210	CCf 125	1250	1320	20	16	8
-	CCf 140	1415	1470	20	16	10
-	CCf 160	1615	1680	24	18	12

Dimensioni in mm - 1400/1600: codice a richiesta
Dimensions in mm - item codes upon request

CCfc | GIUNTO ANTIVIBRANTE | FLEXIBLE CONNECTORS

Controflangia a forma di anello con collare, provvista di fori a norma UNI ISO 6580 – EUROVENT. Viene utilizzata per facilitare il collegamento tra il canale ed il ventilatore.

Counter flange with addition of 80 mm of round duct. It is used for easier connection between the CC fan and the duct.

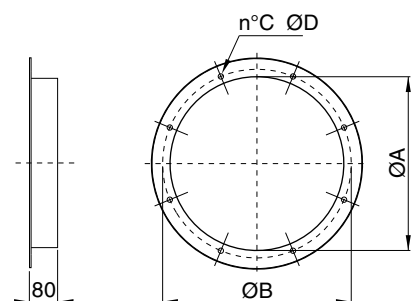

Code	Tipo Type	ØA	ØB	C	ØD	kg
5B01531	CCfc 31	305	355	8	10	1,3
5B01535	CCfc 35	355	395	8	10	1,5
5B01540	CCfc 40	405	450	8	12	1,7
5B01545	CCfc 45	455	500	8	12	2
5B01550	CCfc 50	505	560	12	12	2,2
5B01556	CCfc 56	565	620	12	12	2,5
5B01563	CCfc 63	635	690	12	12	2,9
5B01571	CCfc 71	710	770	16	12	3,3
5B01580	CCfc 80	808	860	16	12	3,8
5B01590	CCfc 90	908	970	16	16	4,2
5B01600	CCfc 100	1010	1070	16	16	5
5B01620	CCfc 112	1130	1190	20	16	5,8
5B01625	CCfc 125	1260	1320	20	16	6,5

Dimensioni in mm | Dimensions in mm
1400/1600: su richiesta | upon request

CCot | TERMINALE CON RETE | OUTLET TERMINAL

Terminale parapiovista con rete di protezione.
Outlet terminal with protection guard.

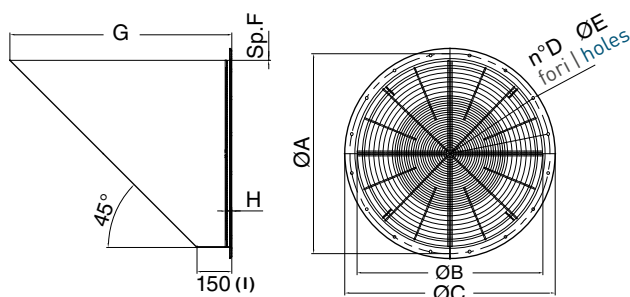

(I) 200 mm da | from CCot 100 a | to 160

Code	Tipo Type	ØA	ØB	ØC	D	ØE	F	G	H	kg
5TR0500	CCot 40	450	400	503	8	12	20/10	550	20	11
5TR0501	CCot 45	500	450	553	8	12	20/10	600	20	11
5TR0502	CCot 50	560	500	603	12	12	20/10	655	20	12,5
5TR0503	CCot 56	620	560	663	12	12	20/10	710	20	15
5TR0504	CCot 63	690	630	733	12	12	20/10	785	20	18
5TR0505	CCot 71	770	710	813	16	12	20/10	865	25	22,5
5TR0506	CCot 80	860	800	903	16	12	30/10	950	25	39
5TR0507	CCot 90	970	900	1013	16	16	30/10	1050	25	48
5TR0508	CCot 100	1070	1000	1113	16	16	40/10	1200	30	80
5TR0509	CCot 112	1190	1120	1233	20	16	40/10	1325	30	97,5
5TR0510	CCot 125	1320	1250	1367	20	16	40/10	1455	30	118
5TR0511	CCot 140	1470	1400	1525	20	16	40/10	1605	30	164
5TR0512	CCot 160	1680	1600	1725	24	16	40/10	1800	30	182

Dimensioni in mm | Dimensions in mm